

VACOMASS®

The modular
aeration control system
in wastewater treatment plants

Reliable, energy-efficient
plant operation made
possible by precise and
efficient aeration control

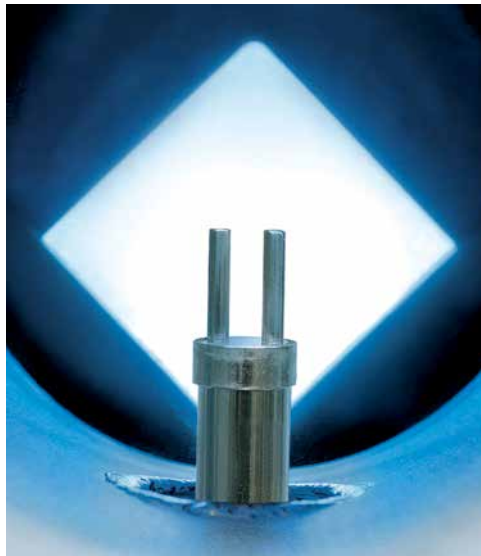

BETTER CONTROL. BETTER ENVIRONMENT.



BINDER
BINDERGROUP

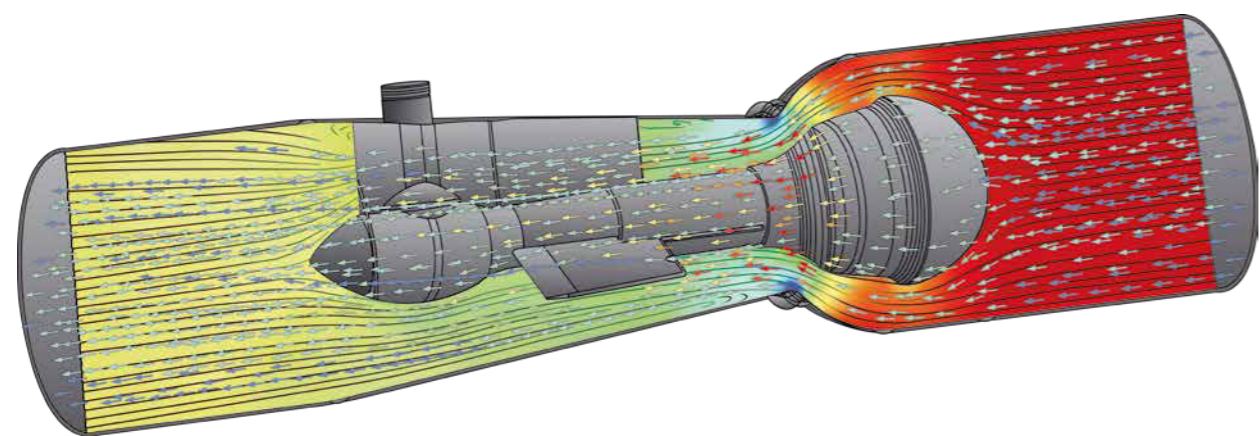

VACOMASS® Biology under control

When the biological stage of a wastewater treatment plant is underaerated, it will lead to process disruptions and effluent limits can be exceeded. However, an over-supply of air wastes blower energy and results in uneconomical operation of the plant. Additionally the denitrification process can be compromised by surplus dissolved oxygen in the internal recirculation.

Only innovative aeration control based on actual demand can ensure both, a reliable and economical plant operation. The modular VACOMASS® system consists of components that are optimized for this application and matched to each other for precise measurement, control and distribution of aeration air.

VACOMASS® ensures that air is supplied according to actual oxygen demand in the various basins and aeration zones of the plant.

VACOMASS® therefore guarantees

- optimized treatment
- avoidance of disruptions to plant operations
- compliance with effluent permits
- and economical operation of your wastewater treatment plant.

With VACOMASS® your biological treatment is under control and energy consumption is significantly reduced.



VACOMASS® System integration

Aeration air has to overcome static and dynamic back pressures, e.g. changes in water level, condition of the diffuser and pressure drop of the piping, on the way to the aeration tank. These factors change over time and are hard to control. Therefore, even very small changes will have a significant influence on the air distribution. This is exactly where the VACOMASS® concept can be applied: Each VACOMASS® control loop continuously monitors the local air supply and detects the smallest deviation from the setpoint. The controller immediately intervenes and compensates any external disturbances of the air distribution. The system integration guarantees optimal interaction of the components even for complex installations.

Simultaneous flow profile correction

In the case of a compact VACOMASS® system installation, the thermal mass flow sensor is positioned directly upstream of the control valve. If the flow profile will change with the stroke of the valve during operation, the reading can be corrected easily by using the stroke related flow profile compensation in the electronics. So air flow based control becomes more precise.

As an alternative flow compensation can be used.

Optimized valve control

Conventional static PI- or PID-controllers change the stroke of the control valve in a stepwise fashion. This inevitably leads to high switching frequencies and premature wear and tear of the actuator and the valve. However, the characteristic control curve of the valve and specific process data of the treatment plant are saved in each VACOMASS® control module. During setpoint deviations, the flexalgorithm with its dynamic control algorithm with artificial intelligence (AI) precisely calculates the new stroke of the control valve.

Plausibility check of signals

The aeration control is based on certain process parameters (e.g. O₂, NH₄-N, etc.). Faulty measurements of these parameters can indicate a low oxygen demand, resulting in an undersupply of aeration air. The VACOMASS® system continuously monitors process signals used in the control loop for availability, plausibility, frozen or jumping readings. In this way any malfunction of sensors can be detected and VACOMASS® reacts to each disruption without delay and automatically initiates appropriate countermeasures (safe-guards). To determine the oxygen demand, only signals of the properly functioning probes continue to be considered.

Diffuser maintenance

To reduce the pressure drop at the diffusers, a periodic and selective flexing and cleaning procedure can be implemented. This not only improves oxygen transfer efficiency but also reduces pressure drop and power consumption of the blowers. The lifetime of the diffusers can be extended.

Alarm and safety functions

VACOMASS® provides comprehensive monitoring functions allowing each process disruption to be indicated immediately. In the case of a fault, the control valve will immediately move into safe position, run in a customized emergency mode or in manual mode directly in the SCADA. This way, VACOMASS® ensures a surplus of oxygen at any time. Consequently, a VACOMASS® installation significantly improves the operational safety of the biological process.



Retrofitting and modernization

The modernization of the wastewater treatment plant at Ulm-Steinhäule in Germany demonstrates the chances for optimization that are now possible with a **VACOMASS® jet control valve**. The common system was designed in the 1990s: a blower station with a generously dimensioned common header to the basins and 20 electrically-operated DN 400 (16 inch) control valves in each drop pipe to the diffuser grids. The common gate valves typically operate in the range of 10 to 30 % stroke only, generating a measurable pressure drop of up to 58 mbar (0.85 psi). With the installation of the **VACOMASS® jet control valve** DN 400 in the

existing pipelines, the air flow rates can be controlled precisely at a fraction of the previous pressure loss. This reduces the header pressure and energy costs significantly. A reduction and expansion of the pipeline was not necessary since the DN 400 **VACOMASS® jet control valve** guarantees accurate operation across the entire control range with as little as 3 to 5 mbar (1.2 to

2 inch WC) pressure drop. The design of the **VACOMASS® jet control valve**, which also functions as a flow conditioner, allows the installation of the air flow meter just 0.5 x D upstream of the control valve with a very short inlet pipe run from the header pipe. Installation was therefore very easy, quick and cost-effective using pre-fabricated pipe sections.



VACOMASS® flow meter
Thermal dispersion mass flow meter for precise monitoring of the air flow at standard conditions

VACOMASS® calibration
Customized calibration of flow meter for best accuracy at site, considering piping layout and others

VACOMASS® hot tapping unit
Hot tapping unit for the flow meter with fixed (OEIN-F) or flexible (OEIN-S) insertion depth and sensor orientation



VACOMASS® jet control valve
Gastight shut-off, aerodynamically optimized stainless steel control valve with a linear operating characteristic over the full stroke range for highly precise air supply at minimum pressure loss.

Constant positioning precision and repeatability across a nearly unlimited control range. Pressure recovery of up to 75% due to low-turbulence flow and venturi outlet. Preventive maintenance-free.

Very short installation lengths thanks to 3D design with integrated flow conditioning and air flow meter 0.5 x D upstream of the control valve.
Patent No. DE102013110581

VACOMASS® actuator
Electrical or pneumatic actuator for precise control of air supply, mounted on the control valves



VACOMASS® square diaphragm control valve
Tried and tested in the market for many years, gastight shut-off, square diaphragm control valve with falling flow axis, with a stable and proportional operating characteristics in the normal operation range



VACOMASS® elliptic diaphragm control valve
Diaphragm valve with falling flow axis, lense-shaped control orifice and gas-tight shut-off. The valve opens the cross-section completely, allowing very high flow rates with minimum pressure drop and low noise emissions due to an integrated pressure wave breaker – especially developed and used for aeration air
Patent No. EP 3 390 871



VACOMASS® flexcontrol
PLC-based modular and user-friendly tool for aeration control, indoor or outdoor installation, can have all standard communication channels and an additional external access. Various software packages are available as individual modules, can be activated and configured customized password-secured on the graphic display (7"-15.6") or directly from control room – no black box!

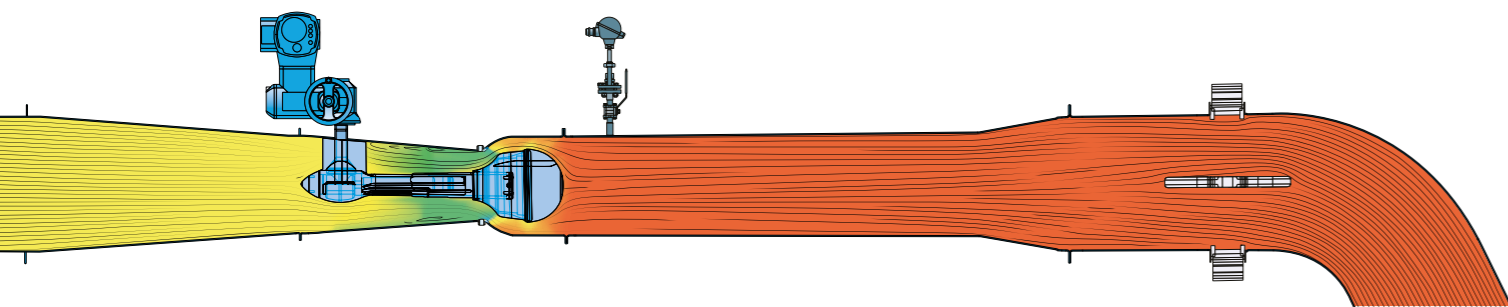

VACOMASS® aeration controller-DO

Dynamic self-learning, self-adjusting controller with AI, calculates actually required air flow rate and related stroke of the valve for permanent and intermitten aeration

VACOMASS® aeration controller-Q

Dynamic self-learning, self-adjusting controller with AI, calculates actually required valve's stroke based on setvalue air flow rate, transmitted from PLC or another controller

VACOMASS® aeration controller-LITE

Classic DO-control, calculates required stroke of the valve based on deviation of actual and set value of DO for small installations without air flow meter

VACOMASS® data acquisition manager

Master system for collection, storage and visualization of process data in plants without SCADA, to be connected with the aeration controller

VACOMASS® econtrol

Based on most open and most important valve (MOV/ MIV) minimum required header pressure or actually required air flow rate, in small plants frequency of the single blower is calculated

VACOMASS® econtrol blower

MCP for automatic and energyefficient control of different types and makes of blowers with AI, combination with the aeration controller allows predictive valve control (PVC) measures

DO-SET NH₄-N/DO-SET N₂O

Calculates a dynamic DO-SET based on actual NH₄-N concentration or NH₄-N-Load, also in combination with actual N₂O-concentration/load, various strategies applicable

VAer-SET

Controls air supply into flexibly aerated/swing zones

Further hardware components e.g. flow conditioner, silencer, tune valves and blow-off valves for the blowers are available. Simulation tools for flow simulation of actual piping layout can be provided for improment of the measuring and control pipe section.

DO-SET KASK

Controls DO-SET for improved load distribution in sequential aerated tanks

biocontrol-L

Switches from permanent to aeration in time cycles ON/OFF in low-load times

IntRezi-SET / RASRezi-SET

Controls of different recirculation rates, various control strategies available

CDos-SET / PDos-SET

Controls dosage of chemicals for advanced nutrient removal

DIFF-MIX

Controls pulse aeration in non-aerated process phases

SENS-CHCK

Monitors signal quality of used sensors for frozen or jumping values, reminder for cleaning and service

DIFF-FLEX / PRESS-REL

For automatic mechanical cleaning of diffuser elements applying air flushing or pressure release

DIFF-CLEAN

Control of chemical cleaning of diffuser elements, keeps air flow rate constant

DIFF-CHCK

Long-term monitoring of the pressure drop of the diffuser

VACOMASS® start-up / fine tuning

Support during installation and start-up of the system, including adaptation of control parameters to the local situation and loads by Binder specialists AT SITE or REMOTE.



VACOMASS®

Valves and actuators

The heart of any control system for air distribution is the valve. It should have a linear operating characteristic, preferably over its full stroke coupled with a low pressure drop. Additionally, the air should exit the valve with low turbulence, to achieve a low noise level and keeping the pipe section to the first drop pipe of the diffuser grid as short as possible.

Binder offers two essentially different types of diaphragm control valves: the proven **VACOMASS® square diaphragm control valve** with a square shaped control orifice and the **VACOMASS® elliptic diaphragm control valve** with a lense shaped control orifice. The **VACOMASS® jet control valve** is superior to both diaphragm control valves in terms of energy efficiency and control accuracy.

VACOMASS® square diaphragm control valve – proven for many years

The **VACOMASS® square diaphragm control valve** has a gas-tight control orifice for precise control of air with low losses. It has a falling flow axis for sensitive control of normal and tangential air flows (e.g. after elbows) according to DIN EN 60534-2-3 and has a proportional opening from 0 to 100%. The operating range in the field is typically from 15 to 85% stroke. Depending on ambient conditions at the installation site, various materials for the valve body, sliding gate plate cover, spindle and gaskets are available.

VACOMASS® elliptic diaphragm control valve – for high air flow capacities in purge mode

The **VACOMASS® elliptic diaphragm control valve** with elliptical control aperture is an enhancement of the proven model with square orifice, however it is specially designed for high flow rates at low pressure drop and low noise level. Due to the geometric shape of the cross-section, a pressure wave breaker is integrated to prevent noise generation. When it is 100% open, the pipe's cross-section is completely open and flow is maximized. The installation length is identical to many sliding gate valves and butterfly valves. So a simple

replacement on existing systems can be realized in order to achieve significantly higher air flow rates with lower pressure drop and better control. This optimization increases the air supply significantly and enables prescribed periodic high air rates to purge and clean the diffusers and increase their life span. The peak pressure of the blowers can be lowered and the risk of blower surge is reduced. If aeration systems, especially blower ageing generates an increased pressure drop, the replacement of the existing valve by a **VACOMASS® elliptic diaphragm control valve** can reduce or prevent this stress situation. Expensive retrofitting measures can be delayed or omitted entirely.

VACOMASS® jet control valve – the exceptional control valve

The **VACOMASS® jet control valve** is unique worldwide and combines aerodynamically optimized design with high precision manufacturing. It has a central control axis and an actuator for sensitive control of air flow. Stroke is adjusted along the flow axis. So the flow attaches to the wall, which allows a fast and high pressure recovery in the outlet. The control body has a very low drag coefficient and therefore requires only a low driving torque.

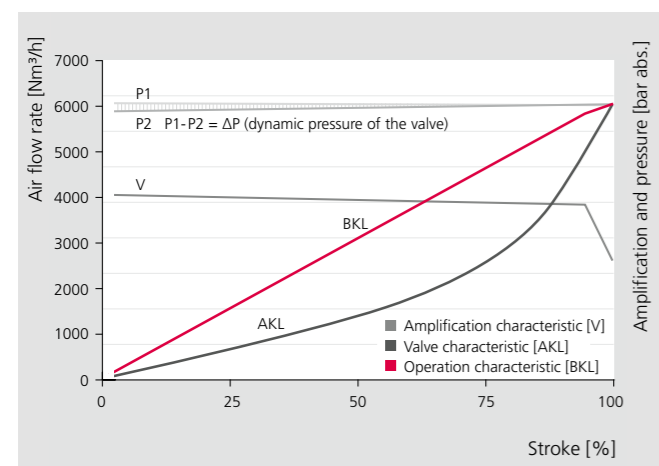

Characteristics of VACOMASS® jet control valve

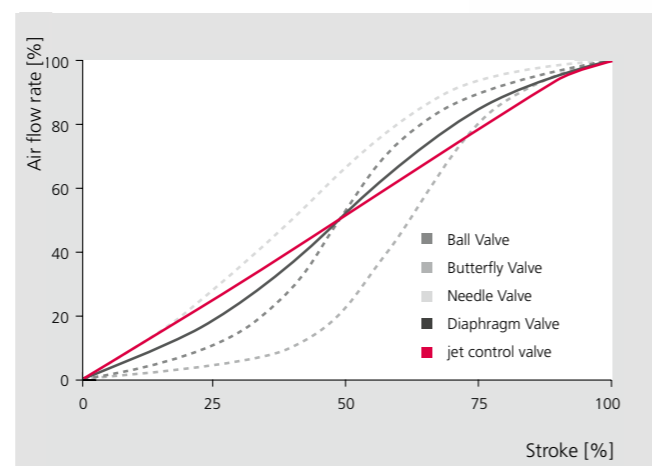

Comparison VACOMASS® jet control valve with conventional valves

It has low friction. A smaller size actuator can be used in many cases. Usually the valve can be connected directly to the pipe without additional reduction and expansion pieces. The control operating characteristic is nearly linear over the valve's entire operating range thanks to the 3D design of the valve trim. The resulting high-precision control characteristics and precision manufacturing of the components allow the resolution of minute control

steps (0.15%). Due to the flow-optimized geometry and up to 75% pressure recovery, the pressure drop is comparatively very low and results in a significant reduction in operating costs. The valve closes 100% gastight. All parts in contact with media are completely made of 316 stainless steel / Teflon / carbon / PEEK / FKM (Viton), suitable for continuous operation at -40 °C to +150 °C (-40 °F to +300 °F) and virtually maintenance-free.

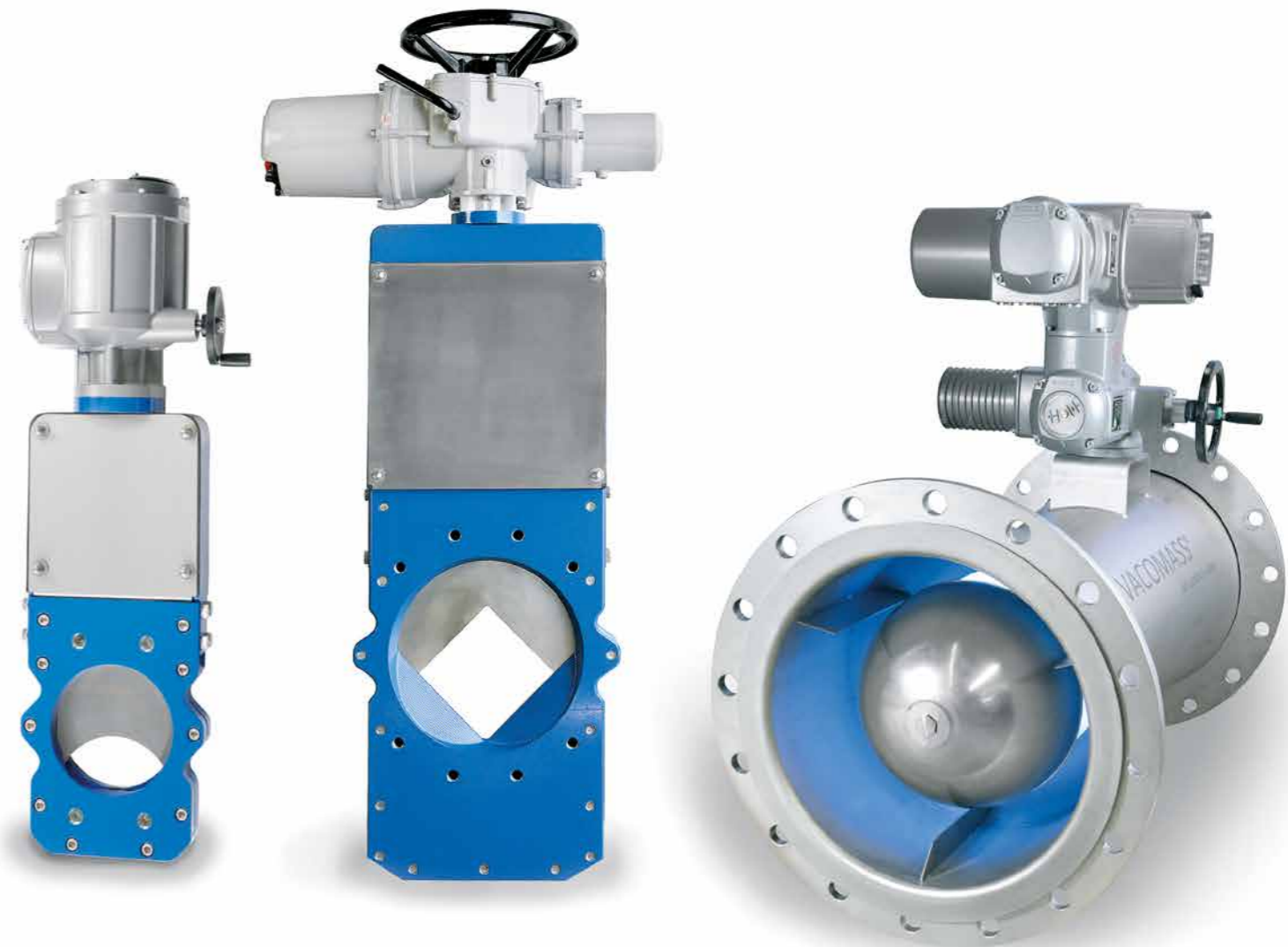

VACOMASS® elliptic diaphragm control valve

VACOMASS® square diaphragm control valve

VACOMASS® jet control valve

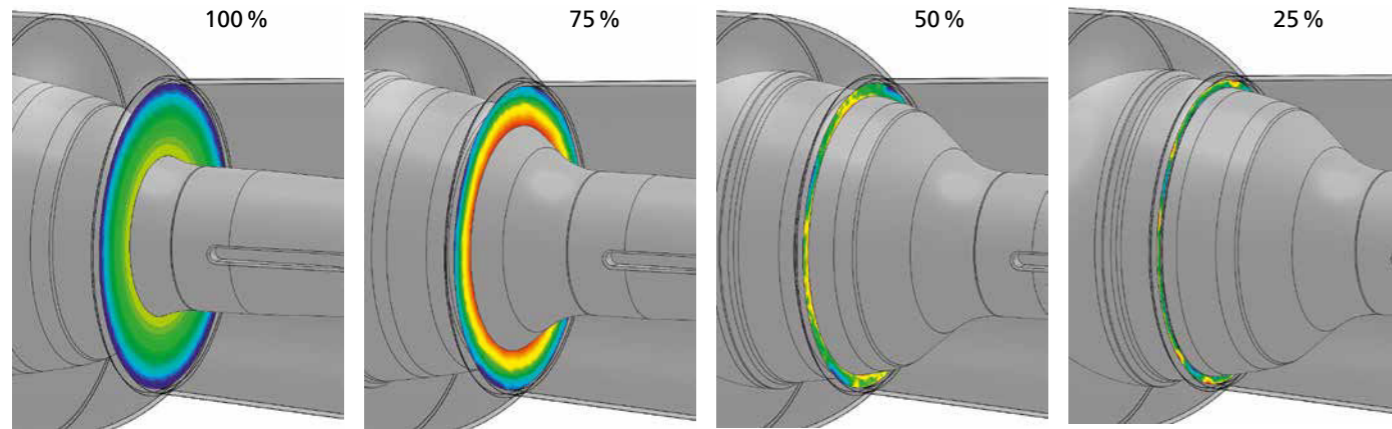

3D design: Over-proportional increase of free flow area leads to the linear operational characteristics

Flow and pressure are equalized at the outlet of the valve hence the first drop pipe to a diffuser grid can be located directly downstream of the valve. This is a big advantage in upgrade projects, can significantly reduce the costs for pipe adaptation while improving the air distribution.

The air flow meter can be placed $0.5 \times D$ upstream of the valve as this position has proven high repeatability of the flow profile, so an easy and cost-effective installation without the usual straight inlet and outlet pipe sections becomes possible.

The development of the **jet control valve** was supported by a CFD (Computational Fluid Dynamics) flow simulation software and parallel flow experiments in the

CAMASS® Calibration Lab at a 1:1 scale, allowing real operational conditions of a plant to be simulated.

In addition to piping orientation, pipe size, pressure, temperature, air mass flow and noise level measurement, the dynamic pressure drop of a plant was simulated.

VACOMASS® actuator

The control valves of the **VACOMASS®** series can be combined with various electrical as well as pneumatic actuators, taking into consideration that the drive of the actuator is optimized for minute steps to achieve a sensitive air adjustment. Depending on ambient conditions at the site, different requirements in corrosion protection, mode of operation, data transmission and actuator duty cycles can be accommodated.



VACOMASS® Airflow meter

Knowledge of the air flow rate at various locations in the aeration system not only improves system understanding, it also provides additional control possibilities.

Typical installation locations are:

- Downstream of the blowers for long-term monitoring of the efficiency in ongoing operation
- In header pipes to individual aeration basins in order to detect and reduce any uneven distribution of wastewater in multi-stream aeration basins
- In branch lines/drop pipes for direct determination of the oxygen supply to an aerated basin or an aerated zone, in order to monitor the ageing of diffusers or incorporate the air flow into the control of the oxygen supply and distribution



The left top photo shows the installation of the VACOMASS® flow meter SS in combination with the torsion-proof hot tapping unit OEIN-F. The right top photo shows the VACOMASS® flow meter AL 100 with the integrated simultaneous flow profile compensation of the flow signal.



Thermal air flow meters are well-suited for all of these measurement tasks. They measure the mass flow at standard conditions directly and require no pressure or temperature compensation, like all other measurement technologies. They also do not generate a pressure drop that would increase the power required by the blowers and raise the electricity costs.

Requirements on the installation location

For precise measurement, they require an evenly-formed flow profile and sufficiently long straight inlet and outlet pipe sections.

For large nominal pipe sizes and/or especially high precision and insufficient straight inlet and outlet pipe sections, a pressure drop-optimized upstream VACOMASS® flow conditioner or a multipoint-sensor-system VACOMASS® flow meter multi with appropriate electronic compensation can be installed.

Alternatively, installation specific calibration in the CAMASS® Calibration Lab can compensate for local flow disturbances so that the precision of the measured value at site improves significantly.

One device, several models

There are several different sensor models available for indoor and outdoor installation. The electronics can be installed in a compact, pressure-proof stainless steel housing (type SS or SS100) with a separate terminal box or in an aluminium housing (types AL, ALDIN or AL100). Optionally, for some housing models, an integrated display is available. All models can have an external graphic display with a separate control panel to display the actual flow value and the totalized value in a field housing, with further type for data transmission to the SCADA (all common bus systems).

Combination with control valves

If the air flow meters are mounted directly upstream of diaphragm control valves, generally a minimum distance is required so that the actual orifice opening does not disturb the flow reading due to flow profile shifts.

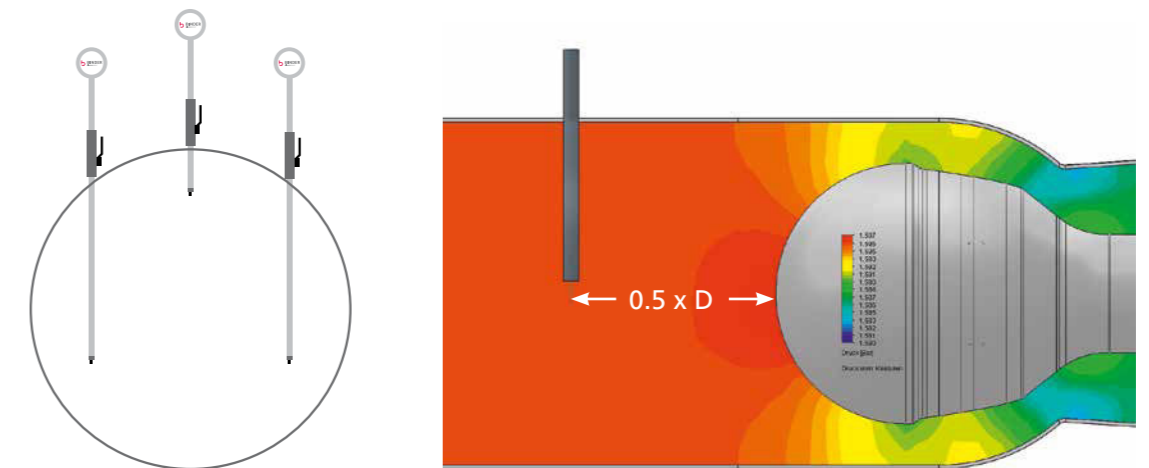

The left top graphic shows the arrangement of a multipoint sensor system mounted in a large collector pipe DN800. So, even with relatively short inlet sections and large diameters, acceptable precision can be achieved.

The CFD picture top right explains one of the advantages and the efficiency of the integrated flow conditioner: the air flow meter can be installed only 0.5 x D in front of the control valve even after extremely short straight inlet piping.

Commonly, and especially in retrofits, this space is not available. In these cases, the flow meter is calibrated together with the valve and the flow-conditioned influence is compensated in the VACOMASS® control modules or directly in the VACOMASS® flow meter AL100/SS100. Actuator's position feedback is transmitted to the analog input in the flow meter for integrated simultaneous flow profile correction. This allows the installation of the flow meter directly upstream of the control valve, thus reducing the required length of the measurement and control pipe section significantly. The VACOMASS® hot tapping unit allows removal of the sensor in operation for maintenance purposes without losing air. Various versions are available, from the simple tap model with variable immersion depth (Version S) to the torsion-proof model with locked installation depth and orientation of the sensor tips (Version F).

VACOMASS® Calibration

Only the exact calibration of an air supply system can provide precise control of the air flow to the aeration basins of a wastewater treatment plant. To achieve this, we can simulate in detail in a scale 1:1, the operating conditions at which our VACOMASS® system will be operated, in our CAMASS® Calibration Lab. For this purpose, the pressure and temperature conditions as well as

the various air flow rates that will occur later in the treatment plant are precisely reproduced during calibration.

Generally, the existing straight pipe sections at the top of the basin are not sufficient long to provide an even flow profile and to position the air flow meter far enough upstream of the control valve.



Factory approval testing (FAT) of the VACOMASS® air supply systems for the municipal sewage treatment plant of Vienna in our CAMASS® Calibration Lab. Due to the precise simulation of the field operating conditions and its piping layout during the calibration of the VACOMASS® systems, a field accuracy of 1.5% of the air flow reading could be guaranteed despite the difficult piping.

In these cases, special calibration allows compact installation: the air flow meter is placed directly upstream of the control valve. The total length of the measurement and control pipe section is thus reduced significantly, and retrofitting is possible even in tight spaces.

When the air flow meter is mounted directly upstream of a VACOMASS® diaphragm control valve, the influence of orifice opening on the flow profile and flow reading can be accurately recorded during calibration. These data enable the calculation of

correction curves and allows precise air flow measurement even under changing operating pressures and loads. Due to the flowconditioning shape of the VACOMASS® jet control valve, the valve position does not influence the air flow signal and the air flow meter can be positioned just $0.5 \times D$ upstream of the control valve.

By exactly replicating the installation situation at site during calibration, the influence of the pipe run on the flow reading can also be recorded and compensated.



VACOMASS® Control concepts

Depending on process, loading and other plant conditions, customized concepts are needed for a reliable and efficient aeration control. The control objective has traditionally been increased process stability and better effluent quality; more recently in addition to the level of capital investment, the focus has moved to the potential for reducing energy costs and so related life cycle costs respectively total costs of ownership.

Approximately two-thirds of a treatment plant's total energy consumption is solely related to the aeration blowers. VACOMASS® always guarantees an air supply tailored precisely to the specific needs in real time.

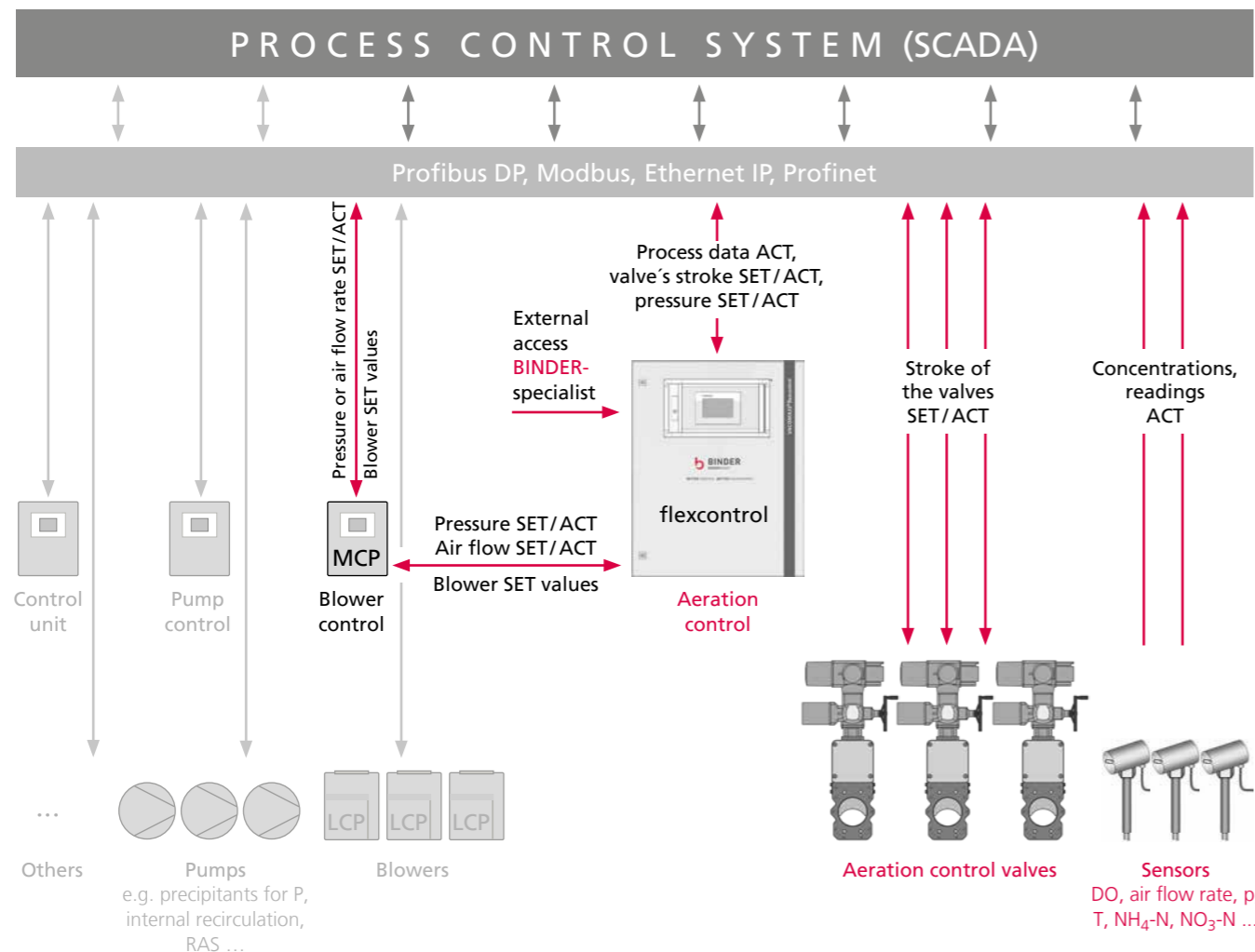

Simple implementation of VACOMASS® flexcontrol into any existing Process Control System

The combination of VACOMASS® system components allows you to implement individual concepts for aeration control. It begins with simple installations to ensure equal air distribution, continues to the implementation of conventional dissolved oxygen control, through to complex installations with cascading control loops and step-feed of wastewater for individual, local air flow control that adjust the dissolved oxygen setpoint based on $\text{NH}_4\text{-N}$ concentration. It is suited due to its extraordinary accuracy also for low DO-control applications. By monitoring the positions of the control valves (MOV/MIV), the header pressure and air flow rates can

be adjusted according to the specific needs, and dynamic header pressure control can be realized. A module for implementing cleaning cycles for the diffusers or pulse aeration can be activated. Based on process parameters such as $\text{NH}_4\text{-N}$, ORP and others, the time phases for nitrification and denitrification in processes with intermittent aeration (incl. SBR), can be determined based on actual load. Load-dependent aerated basins (swing zones) can be switched on or off. Plausibility checks increase process safety in case of signal failure. Standardized control modules allow easy and cost-effective configuration.

Use of air flow rate – cuts energy costs

Since the aeration air is by far the treatment plant's largest energy consumer, in addition to the use of control valves with low pressure drop, special attention should be given to dynamic load-dependent aeration control in real time. Monitoring of the pressure alone is not sufficient for this since the pressure provides no information about the required specific air distribution.

The incorporation of direct air flow measurement into the automation process improves the efficiency and quality of the effluent, especially for large and deep basins or basins with diffusers that do not cover the whole bottom area (see DWA-M 264 Gasdurchflussmessungen auf Abwasserbehandlungsanlagen, April 2022 [DWA-M 264 gas flow measurements in sewage treatment plants, April 2022]).

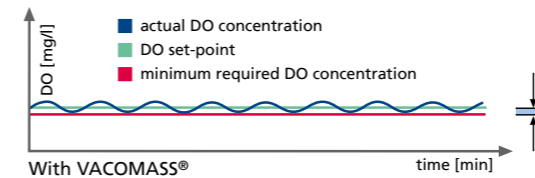
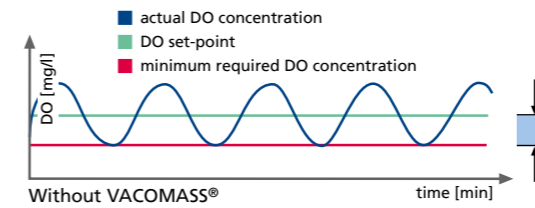

Typically, the dissolved oxygen concentration is measured and the air supply is set via the blowers or control valves. The oxygen concentration fluctuates constantly around the

setpoint. If the air flow in the control loop is used as the setpoint variable for the oxygen concentration, the control system will become much faster.

VACOMASS® uses this air flow based system, reacts immediately to any disruption, so that even in heavy rainfall events the dissolved oxygen concentration generally does not fluctuate much and cleaning performance remains more even. So the dissolved oxygen setpoint can be lowered without compromising the process outcome. Even with the same contamination load, the saturation deficit decreases, as does the air flow rate, and therefore the energy consumption.

Dynamic header pressure control and blower control (MCP)

With constant pressure control, the individual valves provide the required air flow rate to the diffuser grids independently of one another at a fixed pressure level. Many hours a day the required air flow rate and thus the static and dynamic system pressure drop (pipeline and diffuser resistances) are low, and the excess pressure must be dissipated by throttling the control valves.

More economic, however, is the variable adjustment of the blower pressure to the specific air requirement. For this, the VACOMASS® econtrol monitors the actual strokes of the control valves (MOV) as well as availability of dissolved oxygen (MIV) and determines the required pressure level to ensure that just enough air is supplied. By reducing the pressure, the power consumption is also reduced. So an energy-efficient operation is ensured. Alternatively, air flow control can be used. In contrast to pressure-based control, air distribution control is a demand-based calculation of air flow rate.

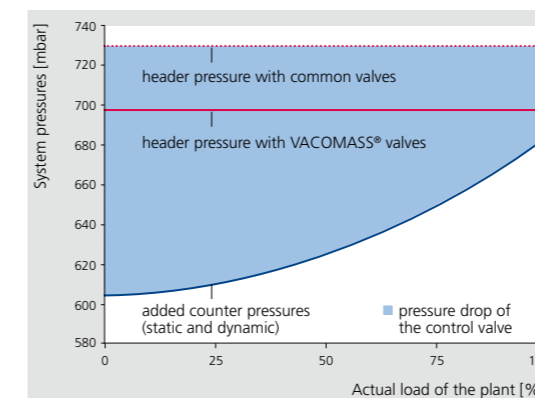

Constant header pressure control

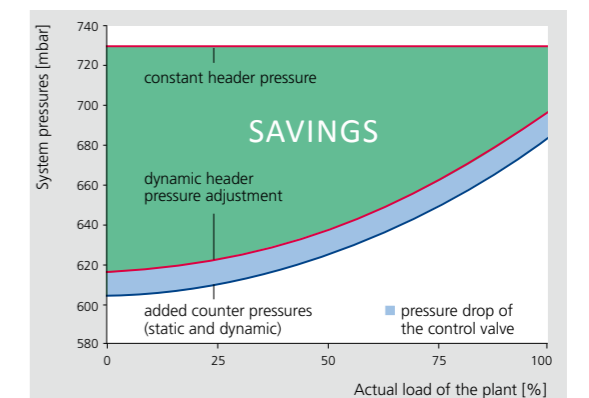

Dynamic pressure control (e.g. with VACOMASS® econtrol)

The VACOMASS® blower management organizes the interplay of several blowers in the air supply system. Detailed timing information about the switching of blowers is incorporated in a smart control algorithms so that the air supply is kept as constant as possible during the blower switch and the danger of surging of blowers can be largely avoided.

VACOMASS® flexcontrol – the PLC-based hardware platform for process control with AI

The control cabinet is suitable for indoor and outdoor installation. Operator input locally is done on the big touch screen with system-specific screens and menus. Different password-protected level secure the appropriate access (RFID on the cabinet, user management system in the control room). The complete flexibility and intuitive operation of this open system is its outstanding feature. It enables easy adaptation to system requirements, no black box that creates uncertainty, but rather standardized modules based on control algorithms that have been used successfully worldwide for many years. All modules can be changed easily by the operator without interruption of processing.

Up to 12 control loops can be implemented in a control cabinet. As many control cabinets as desired can be combined so that larger systems can use the same standardized and thus cost-efficient modules. Each control loop has its own processor with software and process related enabled functions, it works completely independently. This provides

maximum operating reliability and flexibility. Cost-effective fine tuning of control parameters for each individual control loop via remote access is possible. The operator can change the control parameters on-site or remotely at any time. All common interfaces are available. Updates can be installed remotely. The modular structure allows after-the-fact programming and remote download of customer changes. External access via a secured VPN-tunnel represents the current state of the art in terms of remote dial-in. Programming the flexalgorithm as a slave ensures that no access to data in the SCADA is technically possible.

VACOMASS® flexcontrol plus – the advanced hardware platform

A solution for plants without SCADA can be supplied with VACOMASS® data acquisition manager. The freely-expandable number of inputs and outputs and data transmission via bus systems open up possibilities for data recording and evaluation for more sophisticated process monitoring and optimization.

System integration

Only the interaction of all components enables secured and energy-optimized aeration of the biological cleaning stage: from the precise measurement of the air supply to low differential-pressure control valves with linear operating curves and the use of standardized process control functionalities for precise air supply. This frequently reduces energy consumption of blowers typically up to 20% and sometimes even more.

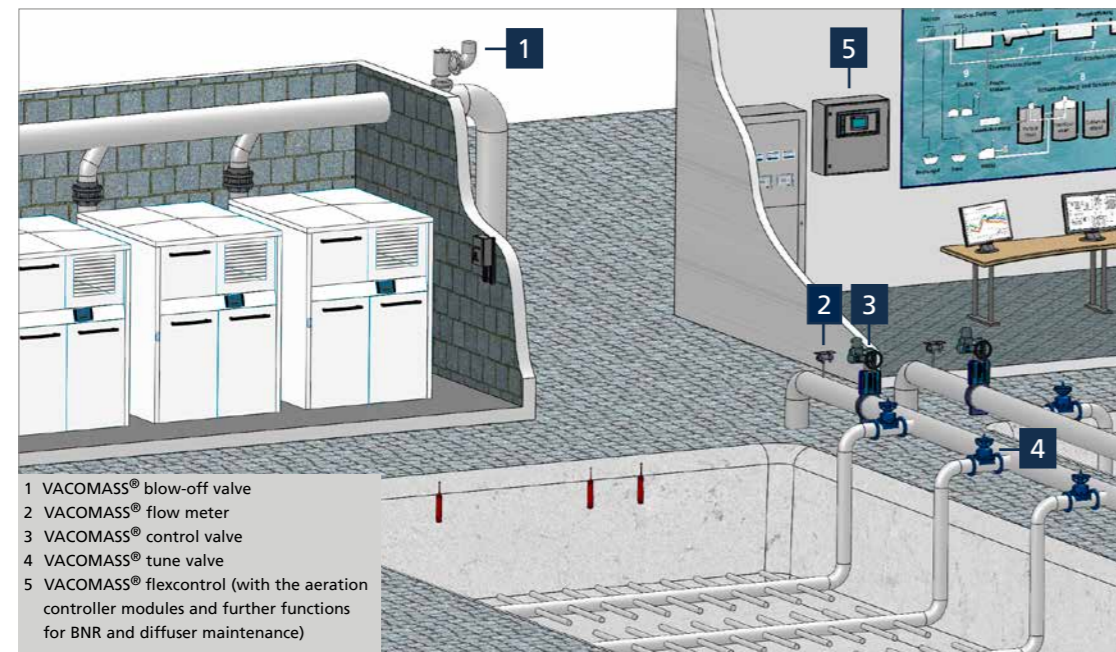

1 VACOMASS® blow-off valve
 2 VACOMASS® flow meter
 3 VACOMASS® control valve
 4 VACOMASS® tune valve
 5 VACOMASS® flexcontrol (with the aeration controller modules and further functions for BNR and diffuser maintenance)





BETTER CONTROL. BETTER ENVIRONMENT.



LOCAL DISTRIBUTOR

PRODUCTION

DISTRIBUTION

BINDER GmbH

Buchbrunnenweg 18
89081 Ulm, Germany
Tel +49 731 18998-0
Fax +49 731 18998-88
info@bindergroup.info
www.bindergroup.info

INSTRUM GmbH

Buchbrunnenweg 18
89081 Ulm, Germany
Tel +49 731 96826-0
Fax +49 731 96826-99
instrum@bindergroup.info
www.instrum.de

BETA BV

Verrijn Stuartlaan 22
2288 EL Rijswijk, The Netherlands
Tel +31 70 3199700
Fax +31 70 3199790
info@beta-b.nl
www.beta-b.nl

Binder Engineering GmbH

Buchbrunnenweg 18
89081 Ulm, Germany
Tel +49 731 96826-0
Fax +49 731 96826-99
info@bindergroup.info
www.bindergroup.info

Binder Engineering AG

Aeschengraben 29
4051 Basel, Switzerland
Tel +41 61 2254444
Tel +49 171 4406909
Tel +49 174 3259324
info@bindergroup.info
www.bindergroup.info

Binder Engineering BV

Cort van der Lindenstraat 25
2288 EV Rijswijk
The Netherlands
Tel +31 70 3074300
Fax +31 70 3074399
sales@binder-engineering.nl
www.bindergroup.info

Binder Engineering NV

Bergensesteenweg 709 A
1600 Sint-Pieters-Leeuw, Belgium
Tel +32 2 3000795
Fax +32 2 3000797
info@binder-engineering.be
www.bindergroup.info

Binder Instrumentation Pte Ltd

4 Battery Road #25-01
Bank of China Building
Singapore 049908
Tel +60 1922 34005
SupportSG@bindergroup.info
www.bindergroup.info

Binder Instrumentation Trading (Shanghai) Co., Ltd

Room 106A
Xingyuan Tech Building
Guiping Road 418
Shanghai, P.R. China, 200233
Tel +86 21 64959889
Fax +86 21 64959887
info@binder-instrumentation.cn
www.bindergroup.info

Binder NA, Inc.

350 Fifth Ave, Suite 5220
New York, NY 10118
United States
Tel +1 941 2102872
SupportUS@bindergroup.info
www.bindergroup.info

Binder Group Latin America

Av. Brasil 1433 dpto 1702
Jesus Maria, Lima, Peru
Tel +51 957 272257
SoporteLA@bindergroup.info
www.bindergroup.info

Binder Group MENA Region

Buchbrunnenweg 18
89081 Ulm, Germany
Tel +49 176 4364 7941
SupportMENA@bindergroup.info
www.bindergroup.info

Please visit our website for more information and distribution in other countries and contact the company shown in red or the local distributor.